

Specification Sheet

838.110.160 S OBLIQUE BRANCH 45°

-Pipe diameter: Ø160mm. Branch diameter: Ø110mm
-Stainless steel: AISI316L/EN1.4404

Product Codes

EAN: 5705499402483
VVS Number: 160224457
RSK Number: 1550319
NRF Number: 2170138
LVI Number: 0251164

Specification

Angle (°): 45
Length (mm): 258
Material: AISI 316L
Material (EN): EN 1.4404
Outlet Diameter (mm): 160
Type: Branches
Weight (kg): 2,11

Approvals



NO - 0692-16



SE - SITAC 4423/90-17



FR - DTA 14.1/12-1811*V2 EuroPipe



AUS - WMKT00204 - 18B



DK - VA 2.12/19349-19



DK - VA 2.12/19350-19

cUPC® US - IAPMO File No.3247-19A



DE - LGA Certificate 57214035 a

MARINE - R4547 NATO CODIFICATION SYSTEM

Bureau Veritas, 02375-H0

Lloyds Register 92-00041 (E7)

RU - 0212322 Pipes-18

ABS - 18-LD1716353-PDA

DNVGL - TAP0000023-rev2

PL - Hygienic Certificate - All products

RINA -MAC285119XG EuroPipe

RS - 19.10097.262

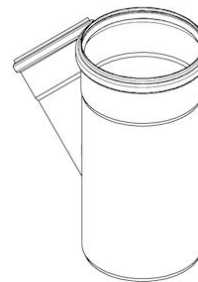
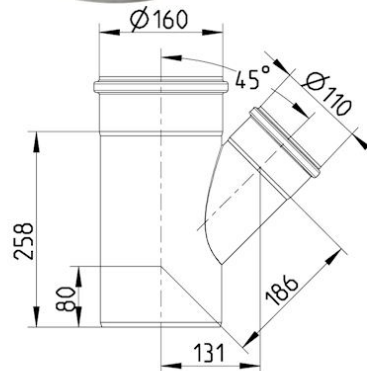

BLÜCHER®

A WATTS Brand

Specification Sheet

Approvals

Achilles Certificate - 25316-20

KR - Type Approval CPH42135-PE001

UR - 1055745

